



SIRIJAYA
INDUSTRIES SDN. BHD.



COMPACT FLUORESCENT LAMPHOLDER - 8 Series

S-820



2G11

2A/500V

T140

14G

500PCS

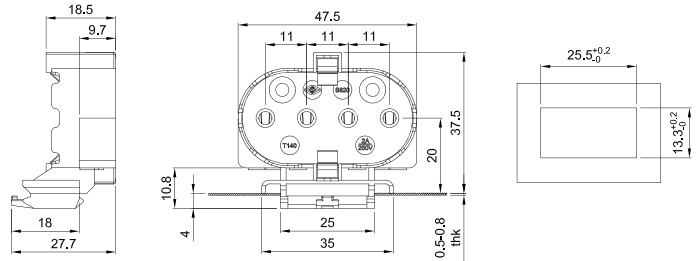

Push-through Fixing

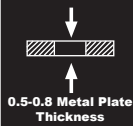

0.5-0.8 Metal Plate Thickness



0.5-1 Rigid Conductor

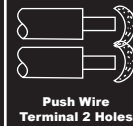

Push Wire Terminal 2 Holes

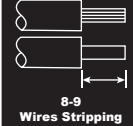

8-9 Wires Stripping

IP20 LAMPHOLDER

- PBT body
- Max. permissible temperature : T140° C

S-821

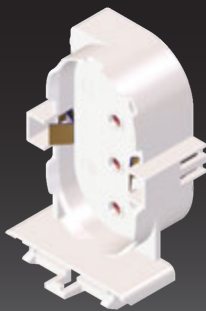

2G11

2A/500V

T140

14G

600PCS

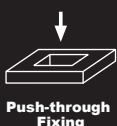
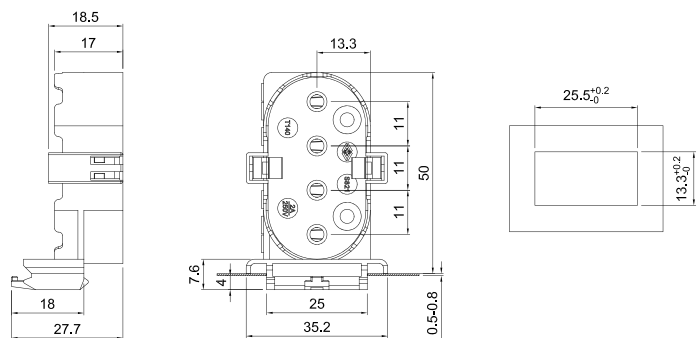

Push-through Fixing

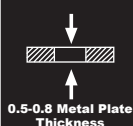

0.5-0.8 Metal Plate Thickness



0.5-1 Rigid Conductor

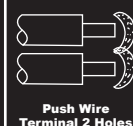

Push Wire Terminal 2 Holes

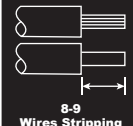

8-9 Wires Stripping

IP20 LAMPHOLDER

- PBT body
- Max. permissible temperature : T140° C



SIRIJAYA
INDUSTRIES SDN. BHD.

No.9 Lebuhr Perusahaan Klebang 9, IGB International Industrial Park, 31200 Chemor, Perak Darul Ridzuan, Malaysia.
Tel: +605- 292 3888 (Hunting Line) 291 2223 - 291 2228 Fax +605-291 2221, 291 2222 www.sirijaya.com