



**SIRIJAYA**  
INDUSTRIES SDN. BHD.



## T5 FLUORESCENT LAMPHOLDER - 9 Series

**S-911**



G5

2A/500V

T110

4G

2500PCS

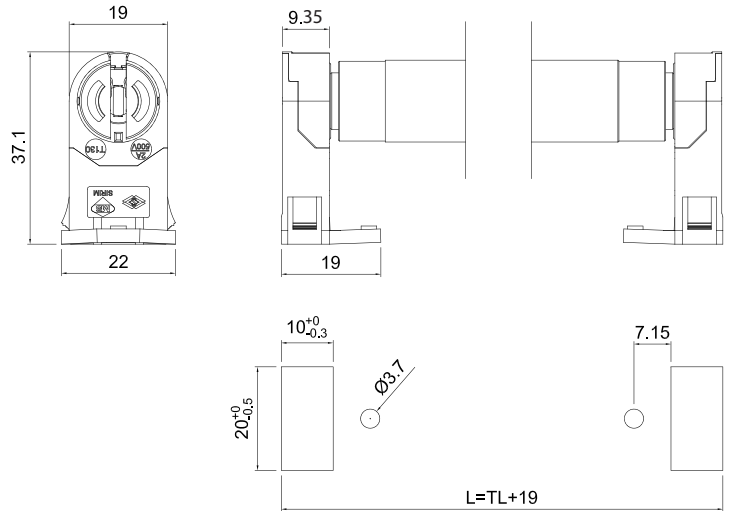

Push-through Fixing

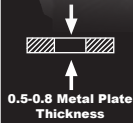

0.5-0.8 Metal Plate Thickness



PBT 45



0.5-1 Rigid Conductor

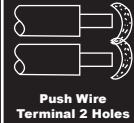

Push Wire Terminal 2 Holes

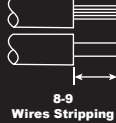

8-9 Wires Stripping

### IP20 LAMPHOLDER

- Polycarbonate body & PBT Rotor  
- Max. permissible temperature T110°C at the rear and front portion of the lampholders.

**S-912**



G5

2A/500V

T110

4G

3000PCS

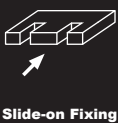
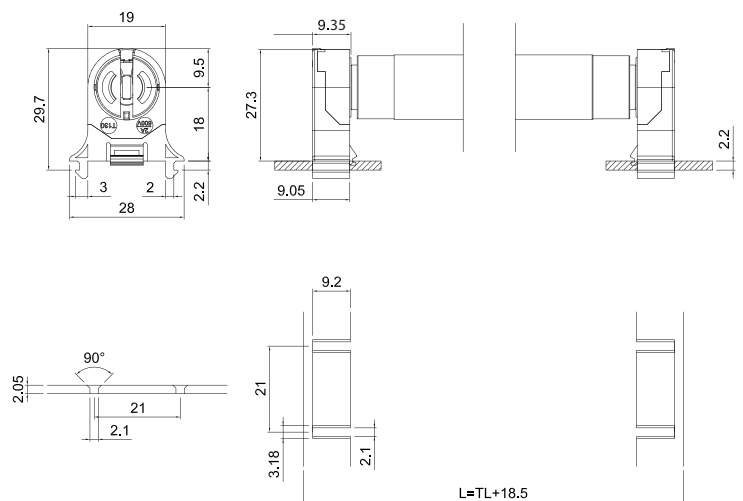

Slide-on Fixing

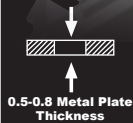

0.5-0.8 Metal Plate Thickness



PBT 45



0.5-1 Rigid Conductor

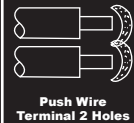

Push Wire Terminal 2 Holes

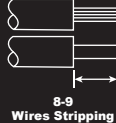

8-9 Wires Stripping

### IP20 LAMPHOLDER

- Polycarbonate body & PBT Rotor  
- Max. permissible temperature T110°C at the rear and front portion of the lampholders.



**SIRIJAYA**  
INDUSTRIES SDN. BHD.

No.9 Lebuhr Perusahaan Klebang 9, IGB International Industrial Park, 31200 Chemor, Perak Darul Ridzuan, Malaysia.  
Tel: +605- 292 3888 (Hunting Line) 291 2223 - 291 2228 Fax +605-291 2221, 291 2222 www.sirijaya.com