

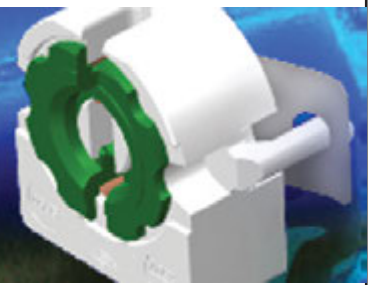

SIRIJAYA
INDUSTRIES SDN. BHD.



T8 FLUORESCENT LAMPHOLDER - 6 SERIES

S-632

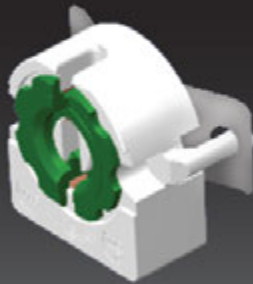

G13

2A/500V

T110

6G

1700PCS

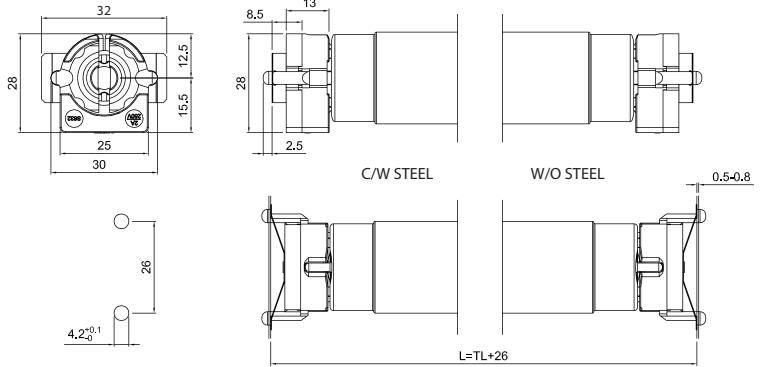

Fixed back
Mounting

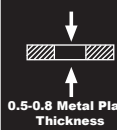

0.5-0.8 Metal Plate
Thickness



PBT
45°



0.5-1
Rigid Conductor



Push Wire
Terminal 2 Holes

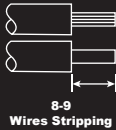

8-9
Wires Stripping

IP20 LAMPHOLDER

- Polycarbonate body & PBT Rotor
- Max. permissible temperature T110°C at the rear and front portion of the lampholders.

S-633

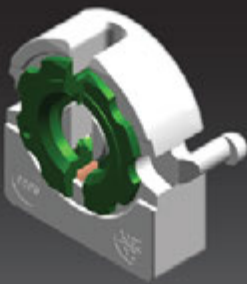

G13

2A/500V

T110

5G

2500PCS

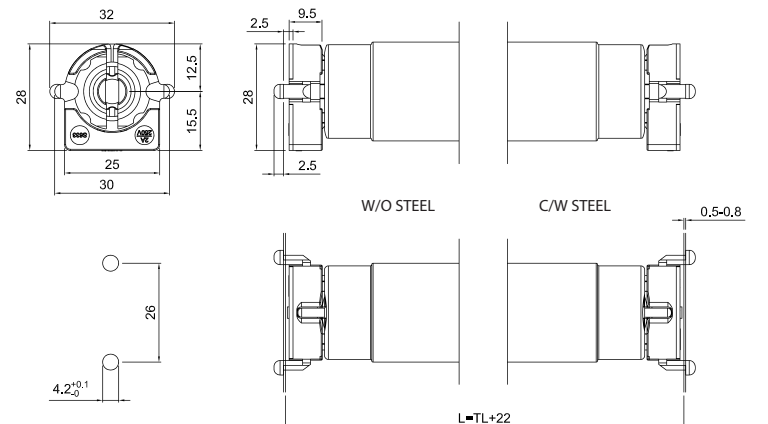

Fixed back
Mounting

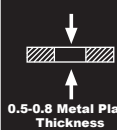

0.5-0.8 Metal Plate
Thickness



PBT
45°



0.5-1
Rigid Conductor



Push Wire
Terminal 2 Holes

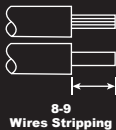

8-9
Wires Stripping

IP20 LAMPHOLDER

- Polycarbonate body & PBT Rotor
- Max. permissible temperature T110°C at the rear and front portion of the lampholders.



SIRIJAYA
INDUSTRIES SDN. BHD.

No.9 Lebuhr Perusahaan Klebang 9, IGB International Industrial Park, 31200 Chemor, Perak Darul Ridzuan, Malaysia.
Tel: +605- 292 3888 (Hunting Line) 291 2223 - 291 2228 Fax +605-291 2221, 291 2222 www.sirijaya.com