



SIRIJAYA
INDUSTRIES SDN. BHD.



T5 FLUORESCENT LAMPHOLDER - 9 Series

S-960

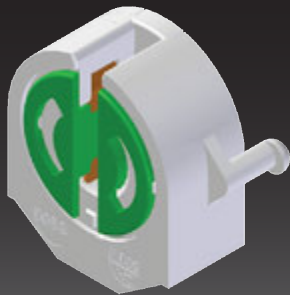

G5

2A/500V

T110

3G

5000PCS

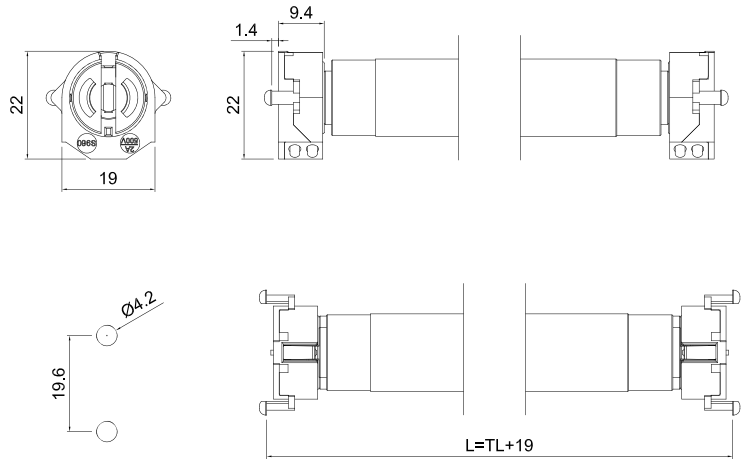

Fixed back
Mounting



0.5-0.8 Metal Plate
Thickness



PBT
45°



0.5-1
Rigid Conductor



Push Wire
Terminal 2 Holes

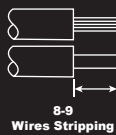

8-9
Wires Stripping

IP20 LAMPHOLDER

- Polycarbonate body & PBT Rotor
- Max. permissible temperature T110°C at the rear and front portion of the lampholders.

S-961



G5

2A/500V

T110

3G

4000PCS

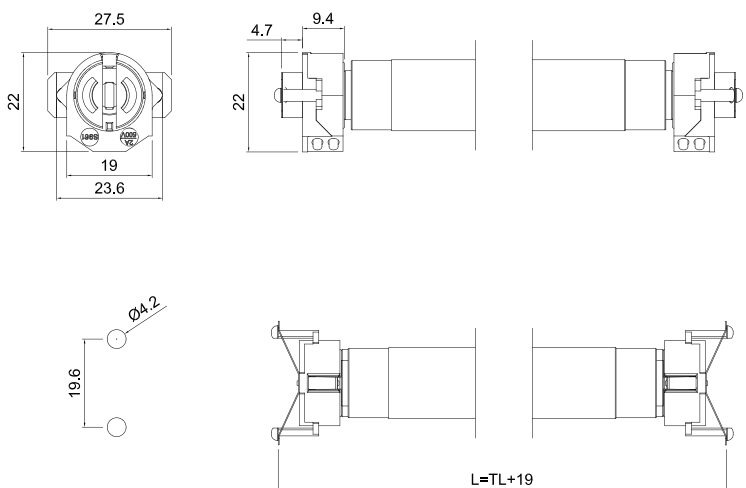

Fixed back
Mounting



0.5-0.8 Metal Plate
Thickness



PBT
45°



0.5-1
Rigid Conductor



Push Wire
Terminal 2 Holes

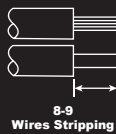

8-9
Wires Stripping

IP20 LAMPHOLDER

- Polycarbonate body & PBT Rotor
- Max. permissible temperature T110°C at the rear and front portion of the lampholders.



SIRIJAYA
INDUSTRIES SDN. BHD.

No.9 Lebuhr Perusahaan Klebang 9, IGB International Industrial Park, 31200 Chemor, Perak Darul Ridzuan, Malaysia.
Tel: +605- 292 3888 (Hunting Line) 291 2223 - 291 2228 Fax +605-291 2221, 291 2222 www.sirijaya.com